

# Badplattformar-segelbåt

Bathing platforms - sailing yachts



En badplattform från Båtsystem passar alltid! Båtsystems unika fästsystem gör underverk för varje omöjlig akterspegel. Våra plattformar är tillverkade i maskinpolerat rostfritt syrafäst stål AISi 316 och solid teak, det bästa som finns för ändamålet. Vill du ha både trygghet, säkerhet och komfort - välj en badplattform från Båtsystem.

A bathing platform from Båtsystem will always fit! Båtsystems unique fastening system makes every impossible stern possible. Our platforms are made from machine polished stainless steel AISi 316 and solid teakwood, the best choice for this purpose. If you want safety, comfort and easy accessibility - choose a bathing platform from Båtsystem.



Linjett 32 - PT8035, BKT73, F2820



Norlin 34 - PT10035, BKT73



Contrast 36 - PT1253530 + BKT73



Kommer våren 2008  
Coming Spring 2008

PT1553530

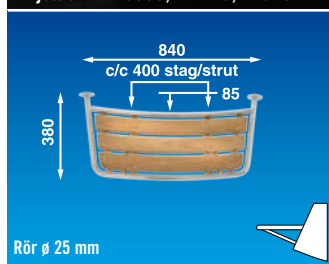

Rör  $\phi$  25 mm

**PT 8035**

Segelbåt. / Sailing yacht.

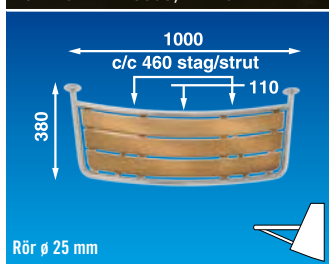

Rör  $\phi$  25 mm

**PT 10035**

Segelbåt. / Sailing yacht.

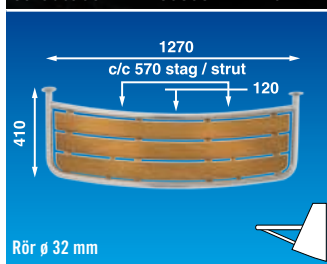

Rör  $\phi$  32 mm

**PT 1253530**

Segelbåt. / Sailing yacht.

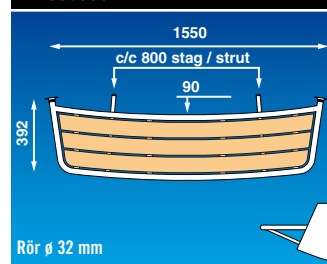

Rör  $\phi$  32 mm

**PT 1553530**

Segelbåt. / Sailing yacht.

Passande stegar / Fitting ladders:  
BKT73, BKT73T, BKT74, BKT74T, BU90

Passande stegar / Fitting ladders:  
BKT73, BKT73T, BKT74, BKT74T, BU90

Passande stegar / Fitting ladders:  
BKT73, BKT73T, BKT74, BKT74T, BU90

Passande stegar / Fitting ladders:  
BKT73, BKT73T, BKT74, BKT74T, BU90

## Stegar / Ladders



**BKT 73**

Teleskopstege i kassett 3 steg med låsning.  
Telescopic ladder in casing, 3 steps with locking.

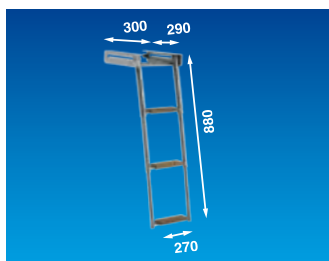

**BKT 73T**

Teleskopstege i kassett 3 teaksteg med låsning.  
Telescopic ladder in casing, 3 teak steps, locking.

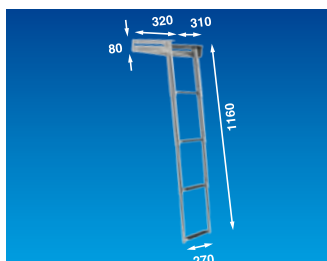

**BKT 74**

Teleskopstege i kassett 4 steg med låsning.  
Telescopic ladder in casing, 4 steps, locking.

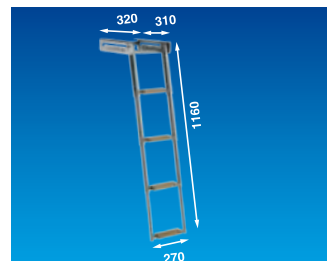

**BKT 74T**

Teleskopstege i kassett 4 teaksteg med låsning.  
Telescopic ladder in casing, 4 teak steps, locking.

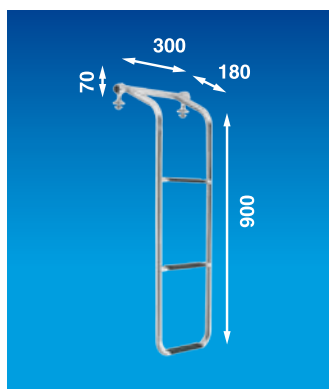

Rör  $\phi$  25 mm

**BU 90**

Uppfällbar stege. Foldable ladder.



Contrast 36 - PT1253530 + BKT73

För val av rätt plattform se sid 29. / Check out page 29 For choosing the right platform.

# Badplattformar-segelbåt

Bathing platforms - sailing yachts



Alla våra badplattformar är tillverkade i maskinpolerat rostfritt syrafast stål AiSi 316 och solid teak.  
All our bathing platforms are made from machine polished stainless steel AiSi 316 and solid teakwood.



HR 29 - PT 1006030 + BK 90



Jeanneau - PT 1256030 + BK 90



Cumulus - PR 1306030, BKT73



Albin MS82 - PM 14060 + BKT73

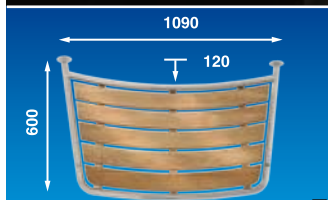

Rör/Tube  $\phi$  32 mm

**PT 1006030**

Segelbåt  
Sailing yacht

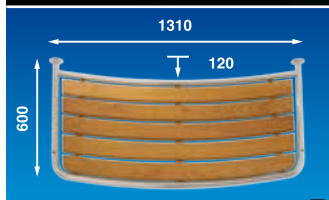

Rör/Tube  $\phi$  32 mm

**PT 1256030**

Segelbåt  
Sailing yacht

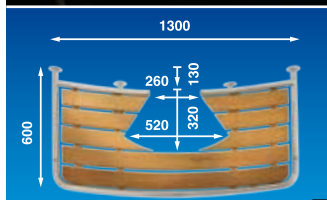

Rör/Tube  $\phi$  32 mm

**PR 1306030**

Segelbåt med utanpåliggande roder. Uttag för roder justeras vid montage.  
Yacht with outside mounted rudder. Adjusted for rudder when mounting.

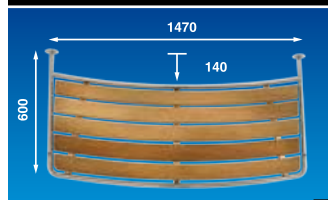

Rör/Tube  $\phi$  25 mm

**PM 14060**

Segelbåt / Albin 25  
Sailing yacht / Albin 25

Passande stegar / Fitting ladders:  
BKT73, BKT73T, BKT74, BKT74T, BK90

Passande stegar / Fitting ladders:  
BKT73, BKT73T, BKT74, BKT74T, BK90

Passande stegar / Fitting ladders:  
BKT73, BKT73T, BKT74, BKT74T

Passande stegar / Fitting ladders:  
BKT73, BKT73T, BKT74, BKT74T

**A** Stag och/eller trämaterial skall finjusteras vid tillpassning på båten. / Supports and/or wooden material should be fine tuned when installed.

## Stegar / Ladders



**BKT 73**

Teleskopstege i kassett 3 steg med låsning.  
Telescopic ladder in casing, 3 steps with locking.

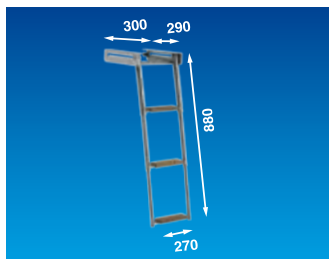

**BKT 73T**

Teleskopstege i kassett 3 teaksteg med låsning.  
Telescopic ladder in casing, 3 teak steps, locking.

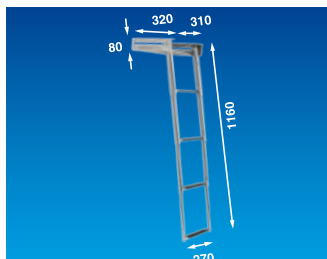

**BKT 74**

Teleskopstege i kassett 4 steg med låsning.  
Telescopic ladder in casing, 4 steps, locking.

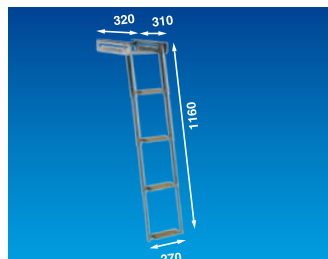

**BKT 74T**

Teleskopstege i kassett 4 teaksteg med låsning.  
Telescopic ladder in casing, 4 teak steps, locking.

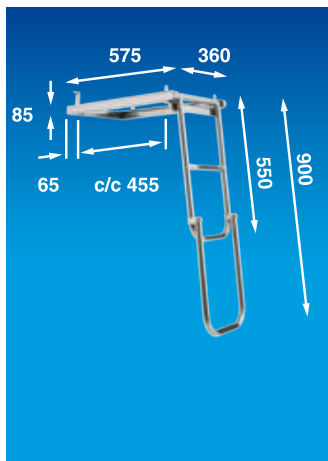

**BK 90**

Stege delad i kassett. 3 steg.  
Ladder, folded in casing. 3 steps.



HR 352 - PT1256030, BK90

För val av rätt plattform se sid 29. / Check out page 29 For choosing the right platform.



# Galleri - badplattformar, segelbåt

Gallery - bathing platforms, sailing yachts



HR 352 - PT1256030, BK90, F2890



Najad 343 - PT 1256030 + BK 90



First 351 - PT 1253530 + BU 90



Fenix - PT1006030 + BK 90



HR29 - PT1006030 + BK90



Wasa 360 - PT10035, BKT73



Scanmar 35 - PT 1006030 + BK90



Norlin 31 - PT8035 + BU90



Jeanneau - PT1256030 + BK 90 + 1300



Maxi84 - PM4550 + BT70



Maxi 999 - PT1253530 + BU 90



HR 352 - PT1256030 + BK 90

Fler bilder hittar du på vår hemsida under galleri / More pictures at our homepage in gallery



# Galleri - badplattformar, segelbåt

Gallery - bathing platforms, sailing yachts



Cumulus - PR1306030, BKT73



X-yacht 342 - PT10035, BKT73



Contrast 33 - PT10035 + BU 90



Malö 116 - PT1256030, BK90, 1300



Mamba 33 - PT8035, BKT73, F2820, 170W



Maxi 95 - PT10035, BKT73, F2820, 170W



Winga 78 - PT1256030, BKT73



Maxi Fenix - PT8035, BU90



Scanner 38 - PT8035, BKT73



Najad 34 - PT1006030, BK90



Omega 36 - BU90, RA-KIT 2



Wasa 420 - PT1253530, RA-KIT (custom)

Fler bilder hittar du på vår hemsida under galleri / More pictures at our homepage in gallery

# Vad passar på din båt?

What fits your boat?



## Ta reda på vilken plattform som passar din båt / Find out which platform fits on your boat

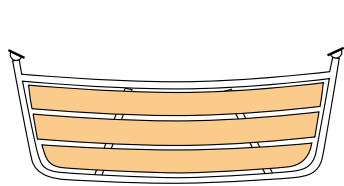

Teaken anpassas normalt inte (utom på speciella plattformar).  
No adjustment for the teak is needed (except on special platforms).

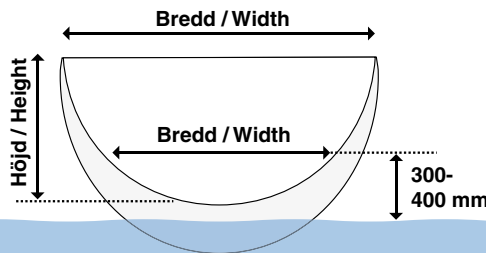

Mät på akterspeglen så ser du vilken plattform som får plats.  
Measure the stern so you will know which platform fits.

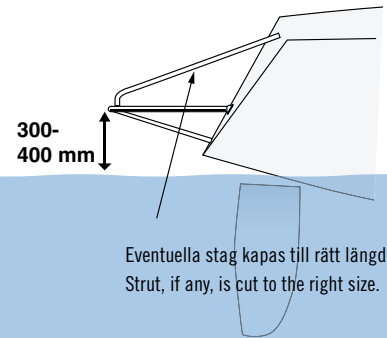

Eventuella stag kapas till rätt längd.  
Strut, if any, is cut to the right size.

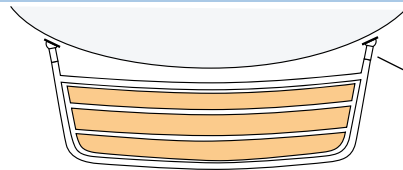

Vid starkt rundad akterspegel kan förlängning monteras.  
If the stern is very round, extensions may be mounted.



P1009

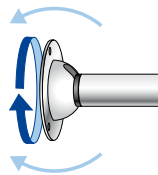

Justerbara universalbeslag för alla vinklar.  
Adjustable universal fittings for all angles.

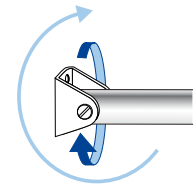

Justerbara u-beslag för alla vinklar.  
Adjustable u-fittings for all angles.

## Peke - passar alltid till din båt / Bow spring - always fits your boat

Välj först vad du vill ha för peke: Långt eller kort och med eller utan ankarhållare. Sedan monterar du bara enligt bifogad monteringsanvisning.

Decide first which bow spring you want: Long or short and with or without anchor holder. Then you mount the bow spring with the installation manual attached.

GPT100,  
GPAT100  
PT10044

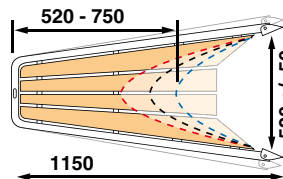

Anpassa teaken efter fören. / Adjust the teak for the bow.

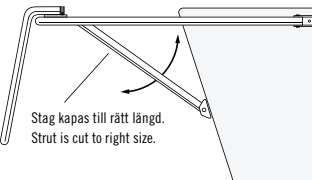
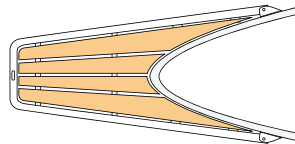

Stag kapas till rätt längd.  
Strut is cut to right size.

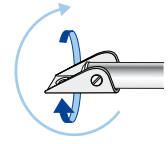

Justerbara u-beslag för alla vinklar.  
Adjustable u-fittings for all angles.

GPT14042 -  
samma princip /  
same procedure

1150

MP75, MPA75

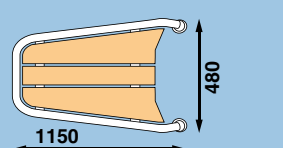

Teaken anpassas normalt inte. / No adjustment for the teak is needed.

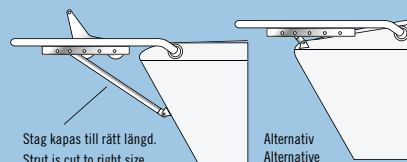
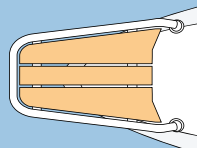

Stag kapas till rätt längd.  
Strut is cut to right size.

Alternativ  
Alternative

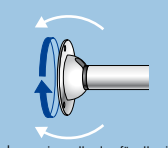

Justerbara universalbeslag för alla vinklar.  
Adjustable universal fittings for all angles.

Vid befintlig ankarhållare kan förlängning monteras.  
If an anchor holder already exists, extensions may be mounted.

P1010

HP 65

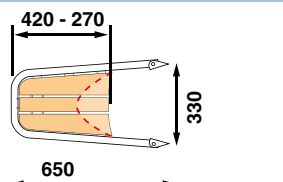

Anpassa teaken efter fören. / Adjust the teak for the bow.

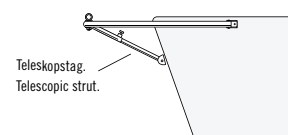
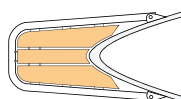

Teleskopstag.  
Telescopic strut.

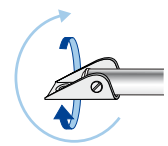

Justerbara u-beslag för alla vinklar.  
Adjustable u-fittings for all angles.

**A** På vissa modeller av peken och badplattformar är stag och trämaterial i "råformat" vid leverans och skall finjusteras vid tillpassning på båten. Se ytterligare information i monteringsanvisningen.

Some models of bow springs come with supports and wooden material in "raw format" and should be fine tuned at installation. Further information is given in the mounting instructions supplied.

# Rekommendationstabeller - segelbåt, akter

Recommendation tables - sailing yachts, stern



BÅTTYP YACHT MODEL	PLATTFORM PLATFORM	STEGE LADDER	FOTSTEG FOOTSTEP	BÅTTYP YACHT MODEL	PLATTFORM PLATFORM	STEGE LADDER	FOTSTEG FOOTSTEP
Albin Accent	PM 4550	BT 70 / BT115	-	Granada 23	PM 4550	BT 70	-
Albin 78	PM 4550	BT 70 / BT115	-	Granada 31	PT 8035	BU90 / BKT73 / BKT74	F2820
Albin 79	PT 8035	BU90 / BKT73 / BKT74	-	Guyline 95	PT 10035	BU90 / BKT73 / BKT74	F2840
Albin Alpha	PT 10035	BU90 / BKT73 / BKT74	-	H 35	PT 8035	BU90 / BKT73 / BKT74	-
Albin Delta	PT 8035	BU90 / BKT73 / BKT74	F2840	H 323	PT 8035	BU90 / BKT73 / BKT74	F2840
Albin Express	PM 4550	BT 70 / BT115	-	HR 26	PM 4550 x 2	BT 70 / BT115	-
Albin Nova	PT 10035	BU90 / BKT73 / BKT74	F2820	HR 26	PR1306030	BKT73 / BKT74	-
Albin Nova	PT 1006030	BK90 / BKT73 / BKT74	F2820	HR 29	PT 1006030	BK90 / BKT73 / BKT74	F2890
Albin Stratus	PT 10035	BU90 / BKT73 / BKT74	F2820	HR 312	PT 1256030	BK90 / BKT73 / BKT74	F2890
Allegro 27-33	PS 55	-	-	HR 352	PT 1256030	BK90 / BKT73 / BKT74	F2890
Amigo 23	PM 4550	BT 70 / BT115	-	HR 36	PT 1256030	BK90 / BKT73 / BKT74	F2820
Amigo 27-30	PS 55	-	-	HR 382	PT 1256030	BK90 / BKT73 / BKT74	F2890
Ansa 42	PT 10035	BU90 / BKT73 / BKT74	F2840	HR 39	PT 1006030	BK90 / BKT73 / BKT74	F2820
Aphrodite 25	PT 10035	BU90 / BKT73 / BKT74	-	HR 42	PT 1256030	BK90 / BKT73 / BKT74	F2890
Aphrodite 30	PT 8035	BU90 / BKT73 / BKT74	F2840	HR 45	PT 1256030	BK90 / BKT73 / BKT74	F2820
Aphrodite 34	PT 8035	BU90 / BKT73 / BKT74	F2820	HR 49	PT 1256030	BK90 / BKT73 / BKT74	F2890
Arcona 32	PT 10035	BU90 / BKT73	-	HR 94 Kutter	PS 55	-	-
Arcona 32	PT 1006030	BK90 / BKT73 / BKT74	-	IW 31	-	BT 72	-
Arcona 36	PT 10035	BU90 / BKT73 / BKT74	F2820	J 105	PT 1253530	BU90 / BKT73 / BKT74	-
Arcona 36	PT 1006030	BK90 / BKT73 / BKT74	F2820	Johnson 23, 26	PM 4550	-	-
Arcona 355	PT 10035	BU90 / BKT73 / BKT74	F2840	Johnson 26	PR1306030	BKT73 / BKT74	-
Athena 34	PT 8035	BU90 / BKT73 / BKT74	F2840	King's Cruiser 33	PT 8035	BU90 / BKT73 / BKT74	F2820
Avance 33	PT 10035	BU90 / BKT73 / BKT74	F2820	L 32	PS 55	-	-
Avance 36	PT 8035	BU90 / BKT73 / BKT74	-	Lady Helmsman	PT 8035	BU90 / BKT73 / BKT74	-
B31	PT 8035	BU90 / BKT73 / BKT74	F2820	Linjett 29/30, 32	PT 8035	BU90 / BKT73 / BKT74	F2820
BB 10	PT 8035	BU90 / BKT73 / BKT74	-	Linjett 35	PT 10035	BU90 / BKT73 / BKT74	F2820
Ballad	PT 8035	BU90 / BKT73 / BKT74	-	Maestro 31	PT 8035	BU90 / BKT73 / BKT74	-
Bandholm 27	PT 8035	BU90 / BKT73 / BKT74	-	Malö 40, 106	PT 1256030	BK90 / BKT73 / BKT74	F2890
Beason 31	PT 10035	BU90 / BKT73 / BKT74	-	Mamba 29, 31	PT 8035	BU90 / BKT73 / BKT74	-
Becker 27	PT 8035	BU90 / BKT73 / BKT74	-	Mamba 34	PT 8035	BU90 / BKT73 / BKT74	F2820
Bellona 29	PT 8035	BU90 / BKT73 / BKT74	-	Mamba 35	PT 1006030	BK90 / BKT73 / BKT74	F2820
Bianca 28	PT 8035	BU90 / BKT73 / BKT74	-	Marieholm 28	PT 1006030	BK90 / BKT73 / BKT74	-
Bianca 101	PT 8035	BU90 / BKT73 / BKT74	-	Marieholm 32	PT 1256030	BK90 / BKT73 / BKT74	F2820
Bianca 320	PT 10035	BU90 / BKT73 / BKT74	F2840	Marieholm MS20	PM 4550	BT 70 / BT115	-
Bianca Lido	PT 10035	BU90 / BKT73 / BKT74	F2820	Marieholm S20	PM 4550	BT 70 / BT115	-
Bianca Riviera	PT 10035	BU90 / BKT73 / BKT74	F2820	Mascot 28	PT 1006030	BK90 / BKT73 / BKT74	-
Birdie 32	PT 8035	BU90 / BKT73 / BKT74	F2820	Maxi 33, 34	PT 1253530	BU90 / BKT73 / BKT74	F2840
Bumerang	PT 8035	BU90 / BKT73 / BKT74	F2820	Maxi 68	PM 4550	BT 70 / BT115	-
C&C 25	PM 4550	BT 70 / BT115	-	Maxi 77	PM 4550 (x2)	BT 70 / BT115	-
C&C 30E	PT 10035	BU90 / BKT73 / BKT74	F2820	Maxi 77	PR1306030	BKT73 / BKT74	-
Carrera	PT 8035	BU90 / BKT73 / BKT74	-	Maxi 80 Racer	PM 4550	BT 70 / BT115	-
Cayenne	PT 10035	BU90 / BKT73 / BKT74	-	Maxi 84	PM 4550 x 2	BT 70 / BT115	F2890
Cenit 33	PT 10035	BU90 / BKT73 / BKT74	F2840	Maxi 84	PR1306030	BKT73 / BKT74	-
Comfort 30	PT 8035	BU90 / BKT73 / BKT74	F2820	Maxi 87	PT 8035	BU90 / BKT73 / BKT74	F2820
Comfort 32	PT 10035	BU90 / BKT73 / BKT74	-	Maxi 87	PT 10035	BU90 / BKT73 / BKT74	F2820
Comfort 32	PT 1006030	BK90 / BKT73 / BKT74	-	Maxi 95	PT 10035	BU90 / BKT73 / BKT74	F2820
Comfort 34	PT 8035	BU90 / BKT73 / BKT74	F2820	Maxi 95	PT 1006030	BK90 / BKT73 / BKT74	F2820
Comfortina 32	PT 10035	BU90 / BKT73 / BKT74	-	Maxi 100PS	PT 1006030	BK90 / BKT73 / BKT74	F2820
Comfortina 32	PT 1006030	BK90 / BKT73	-	Maxi 108	PT 1006030	BK90 / BKT73 / BKT74	F2820
Compis 97	PT 8035	BU90 / BKT73 / BKT74	-	Maxi 900/909/	PT 1253530	BU90 / BKT73 / BKT74	-
Conquibin 38	PT 8035	BU90 / BKT73 / BKT74	F2820	Maxi 999	PT 1253530	BU90 / BKT73 / BKT74	F2840
Contrast 33	PT 1253530	BU90 / BKT73 / BKT74	F2820	Maxi Fenix	PT 10035	BU90 / BKT73 / BKT74	-
Contrast 33	PT 1256030	BK90 / BKT73 / BKT74	F2820	Maxi Fenix	PT 1006030	BK90 / BKT73 / BKT74	-
Contrast 36	PT 1253530	BU90 / BKT73 / BKT74	F2820	Maxi Magic	PM 4550 x 2	BT 70 / BT115	-
Contrast 36	PT 1256030	BK90 / BKT73 / BKT74	F2820	Maxi Magic	PR1306030	BKT73 / BKT74	-
Crown 31	PT 10035	BU90 / BKT73 / BKT74	F2840	Mikkel 30	PT 8035	BU90 / BKT73 / BKT74	-
Cumulus	PM 4550 x 2	BT 70 / BT115	-	Mistinguette	PT 8035	BU90 / BKT73 / BKT74	F2820
Cumulus	PR1306030	BKT73 / BKT74	-	Monark 540	PM 4550	BT 70 / BT115	-
Dehler 31	PT 1253530	BU90 / BKT73 / BKT74	F2840	Monark 700	PM 4550	BT 70 / BT115	-
Dehler 33	PT 1253530	BU90 / BKT73 / BKT74	F2820	Monsun 31	PT 1006030	BK90 / BKT73 / BKT74	F2820
Dehler 33	PT 1256030	BK90 / BKT73 / BKT74	F2820	Murena	PT 8035	BU90 / BKT73 / BKT74	-
Diva 39	PT 10035	BU90 / BKT73 / BKT74	F2820	My Helmsman 20	-	BT 72	-
Dixie 27	PT 8035	BU90 / BKT73 / BKT74	-	Najad 34	PT 1006030	BK90 / BKT73 / BKT74	F2890
Dixie 32	PT 10035	BU90 / BKT73 / BKT74	F2840	Najad 320	PT 1006030	BK90 / BKT73 / BKT74	-
Dominant 95	PT 10035	BU90 / BKT73 / BKT74	-	Najad 343	PT 1256030	BK90 / BKT73 / BKT74	F2890
Elvström 6.5	PM 4550	BT 70 / BT115	-	Najad 360	PT 1253530	BU90 / BKT73 / BKT74	F2820
Facil 26	PT 8035	BU90 / BKT73 / BKT74	-	Najad 360	PT 1256030	BK90 / BKT73 / BKT74	F2820
Facil 30	PT 10035	BU90 / BKT73 / BKT74	F2840	Najad 29	PT 10035	BU90 / BKT73 / BKT74	F2820
Facil 35	PT 10035	BU90 / BKT73 / BKT74	F2820	Naver 80	PT 10035	BU90 / BKT73 / BKT74	-
Fantasi 37	PT 1006030	BK90 / BKT73 / BKT74	F2820	Nord 80	PT 1006030	BK90 / BKT73 / BKT74	-
Finnexpress	PT 10035	BU90 / BKT73 / BKT74	-	Nordisk familjebåt	PM 4550 x 2	BT 70	-
Finnfire 33	PT 8035	BU90 / BKT73 / BKT74	F2820	Nordisk familjebåt	PR1306030	BKT73 / BKT74	-
Finnflyer 31	PT 10035	BU90 / BKT73 / BKT74	F2840	Nordship 808	PM 4550	BT 70 / BT115	-
First 235	PM 4550	BT 70	-	Norlin 34	PT 10035	BU90 / BKT73 / BKT74	-
First 28	PT 10035	BU90 / BKT73 / BKT74	-	OE 32	PS 55	-	-
First 32/325	PT 10035	BU90 / BKT73 / BKT74	F2840	OE 36	PT 8035	BU90 / BKT73 / BKT74	F2820
First 35S5	PT 1253530	BU90 / BKT73 / BKT74	F2840	Ohlson 22	PT 10035	BU90 / BKT73 / BKT74	-
Forgus 31	PT 10035	BU90 / BKT73 / BKT74	F2820	Ohlson 28'	PT 10035	BU90 / BKT73 / BKT74	F2890
Forgus 31	PT 1006030	BK90 / BKT73 / BKT74	F2820	Ohlson 28	PT 1006030	BK90 / BKT73 / BKT74	F2890
Forgus 36	PT 10035	BU90 / BKT73 / BKT74	F2820	Ohlson/Winga 29	PT 10035	BU90 / BKT73 / BKT74	-
Forgus 36	PT 1006030	BK90 / BKT73 / BKT74	F2820	Ohlson 88	PT 10035	BU90 / BKT73 / BKT74	F2890
Fortissimo	PR 1306030	BK90 / BKT73 / BKT74	F2840	Ohlson 88	PT 1006030	BK90 / BKT73 / BKT74	F2890

Kompleta monteringsanvisningar finns på vår hemsida. / You will find installation manuals on our homepage.



# Rekommendationstabeller - segelbåt, akter

Recommendation tables - sailing yachts, stern



BÅTTYP YACHT MODEL	PLATTFORM PLATFORM	STEGE LADDER	FOTSTEG FOOTSTEP	BÅTTYP YACHT MODEL	PLATTFORM PLATFORM	STEGE LADDER	FOTSTEG FOOTSTEP
Omega 28	PT 8035	BU90 / BKT73 / BKT74	-	Sunwind 29	PT 1006030	BK90 / BKT73 / BKT74	F2820
Omega 30	PT 10035	BU90 / BKT73 / BKT74	-	Sunwind 30	PT 10035	BU90 / BKT73 / BKT74	F2840
Omega 34	PT 8035	BU90 / BKT73 / BKT74	F2820	Swan 37	PT 8035	BU90 / BKT73 / BKT74	F2820
Omega 36	PT 10035	BU90 / BKT73 / BKT74	F2820	Swede 38	PT 10035	BU90 / BKT73 / BKT74	-
Omega 36	PT 1006030	BK90 / BKT73 / BKT74	F2820	Swede 55	-	BT 70	-
Omega 42	PT 8035	BU90 / BKT73 / BKT74	-	Sweden Yachts 36	PT 10035	BU90 / BKT73 / BKT74	F2840
P 28	PM 4550	BT 70 / BT115	-	Sweden Yachts 340	PT 1253530	BU90 / BKT73 / BKT74	F2840
Parant	PT 1256030	BK90 / BKT73 / BKT74	-	Targa 96	PT 10035	BU90 / BKT73 / BKT74	F2820
Passad	-	BT 72	-	Trio 80	PT 8035	BU90 / BKT73 / BKT74	-
Primvent 23	PM 4550	BT 70 / BT115	-	Triss Magnum 600	PM 4550	BT 70 / BT115	-
RB 98	PT 1006030	BK90 / BKT73 / BKT74	F2820	Triss Norlin	PM 4550	BT 70 / BT115	-
Rasmus 35	PT 1256030	BK90 / BKT73 / BKT74	F2820	Vagabond 31	PS 55	-	-
Rhapsody	PT 8035	BU90 / BKT73 / BKT74	-	Valiant 18	PM 4550	BT 70	-
Rock 20/24	PT 8035	BU90 / BKT73 / BKT74	-	Vega	PT1006030	BK90 / BKT73 / BKT74	F2820
S 30	-	BT 72	-	Vindö 32	PT 8035	BU90 / BKT73 / BKT74	-
Scampi	PT 8035	BU90 / BKT73 / BKT74	-	Vindö 40	PT 8035	BU90 / BKT73 / BKT74	-
Scanmar 31	PT 10035	BU90 / BKT73 / BKT74	F2840	Vindö 45	PT 1006030	BK90 / BKT73 / BKT74	F2820
Scanmar 33, 35	PT 1006030	BK90 / BKT73 / BKT74	F2820	Vindö 50	PT 10035	BU90 / BKT73 / BKT74	F2820
Scanmar 345	PT 1253530	BU90 / BKT73 / BKT74	F2840	Viggen	PT 10035	BU90 / BKT73 / BKT74	-
Scanner 38	PT 10035	BU90 / BKT73 / BKT74	F2820	W 30 Kompromiss	PT 8035	BU90 / BKT73 / BKT74	F2820
Sea Cat	PT 8035	BU90 / BKT73 / BKT74	-	Wasa 30	PT 8035	BU90 / BKT73 / BKT74	-
Senorita Helmsman	PT 10035	BU90 / BKT73 / BKT74	F2840	Wasa 38	PT 1253530	BU90 / BKT73 / BKT74	F2840
Sheriff 600	PM 4550	BT 70 / BT115	-	Wasa 360	PT 10035	BU90 / BKT73 / BKT74	F2840
Shipman 28	PT 8035	BU90 / BKT73 / BKT74	-	Williamskryssaren	PT 1006030	BK90 / BKT73 / BKT74	F2820
Singoalla	PT 1006030	BK90 / BKT73 / BKT74	F2820	Willing 31	PT 10035	BU90 / BKT73 / BKT74	F2820
Sirena 38	PT 10035	BU90 / BKT73 / BKT74	F2840	Winga 860	PT 10035	BU90 / BKT73 / BKT74	F2840
Smaragd	-	BT 72	-	Winga 87	PT 1256030	BK90 / BKT73 / BKT74	-
Smaragd Cruiser	-	BT 72	-	X 79	PT 10035	BU90 / BKT73 / BKT74	-
Solus 24	PT 8035	BU90 / BKT73 / BKT74	-	X 95	PT 10035	BU90 / BKT73 / BKT74	-
Sunwind 26/27	PT 10035	BU90 / BKT73 / BKT74	-	X 99, 102	PT 1253530	BU90 / BKT73 / BKT74	F2840
Sunwind 29	PT 10035	BU90 / BKT73 / BKT74	F2820	X 332	PT 1253530	BU90 / BKT73 / BKT74	F2840

# Rekommendationstabeller - motorbåt, snipa

Recommendation tables - power boat, gig

SNIPA, Spetsgafflad akter GIG	PLATTFORM PLATFORM	STEGE LADDER	FOTSTEG FOOTSTEP	MOTORBÅT POWERBOAT	PLATTFORM PLATFORM	STEGE LADDER	FOTSTEG FOOTSTEP
Nauticat 33	PS65	BUT125	-	Albin 25	PM14060	BKT73 / BKT74	-
Brofjord 36	PS65	-	-	Albin MS82	PM14060	BKT73 / BKT74	-
Stigfjord 27	PS65	-	-	Nimbus 21	PM19050	BKT73 / BKT74 / BUT45 / BUT47	-
Joda	PS65	-	-	Nimbus 22DC	PMR1803530	BKT73 / BKT74 / BUT45	-
Stureholmssnipa	PS65	-	-	Antares 620	PM1803530	BKT73 / BKT74 / BUT45	-
Viksund 27	PS55	-	-				



Kompleta monteringsanvisningar finns på vår hemsida. / You will find installation manuals on our homepage.

[www.batsystem.se](http://www.batsystem.se)