

**GLOMEX**<sup>®</sup>  
*The best in marine antennas*



**weBoat 4G**

**INTEGRATED 3G/4G/WI-FI SYSTEM**  
**To browse the Internet along the coast**

**USER AND INSTALLATION MANUAL**

**LABEL**

## TECHNICAL SPECIFICATIONS

Antenna dimensions (diam.x H): 250 x 300 mm / 10x12"

Antenna weight: 1,2 kg / 2,65 lb

Automatic switch from Wi-Fi registered networks to 4G.

4G backup WAN function

LTE 4G up to 100 Mbps in download and 50 Mbps in upload

DC- HSPA+ up to 42 Mbps in download and 5.76 Mbps in upload

Four Ethernet ports

2 Diversity (high) performance antennas

SMS reboot function

Android and iOS App for an easy control

Easy installation require only power supply connection 12/24V

UV waterproof resistant Dome

## General Features

LTE FDD bands: B1/B2/B3/B5/B7/B8/B20

DC- HSPA+/HSPA+/HSPA/UMTS: 850/900/1900/2000 MHz

GSM/GPRS/EDGE: 1900/1800/900/850 MHz

Power Class 3 (23 dBm) for LTE FDD

Power Class 3 (24 dBm) for UMTS

Power Class E2 (26 dBm) for EDGE 1800/1900 MHz

Power Class E2 (27 dBm) for EDGE 850/900 MHz

Power Class 1 (30 dBm) for GSM/GPRS 1900/1800 Mhz

Power Class 4 (33 dBm) for GSM/GPRS 900/850 Mhz

## Data

Mode LTE: DL 100 Mbps - 50 Mbps UL

DC-HSPA+: DL 42 Mbps - 5.76 Mbps UL

WCDMA PS: DL 384 Kbps - 384 Kbps UL

EDGE: DL 236,8 Kbps - 236,8 Kbps UL

GPRS: DL 85,6 Kbps - 85,6 Kbps UL

Complies with IEEE 802.11n, IEEE 802.11g and IEEE 802.11b wireless

Complies with IEEE 802.3 and IEEE 802.3u Ethernet standards - I Access point for connecting Wi-Fi



# **INDEX**

1.	FOREWORD . . . . .	4
1.1	DELIVERY LETTER . . . . .	4
1.2	IDENTIFICATION weBBoat . . . . .	4
1.3	WARRANTY . . . . .	4
1.4	GENERAL SAFETY RULES . . . . .	5
1.5	ENVIRONMENT . . . . .	6
2.	PRODUCT DESCRIPTION . . . . .	6
3.	CONTENTS . . . . .	8
3.1	INSTALLATION . . . . .	9
3.2	INSERTING THE SIM CARD . . . . .	13
4.	HOW TO DOWNLOAD CONTROL APP FOR weBBoat . . . . .	14
5.	FIRST TIME SETUP . . . . .	16



# weBBoat 4G

## 1. FOREWORD

### 1.1 DELIVERY LETTER

Welcome: with the installation of this antenna, the world of fast Internet comes on board your boat.

This manual has been drafted in order to help you with the correct installation and operation of the weBBoat to meet all your requirements.

### 1.2 IDENTIFICATION weBBoat

For any communication with GLOMEX or its service center, always have the **serial number** and the **model** of the weBBoat shown on page one of the manual, on the packaging and on the router inside the weBBoat.

### 1.3 WARRANTY

GLOMEX guarantees the weBBoat IT1004 against conformity defects for a period of 24 (twenty-four) months from the date of shipment.

Warranty is intended as the repair or replacement of the equipment showing conformity defects when entering the sales contract, with no charge for the materials.

In case of conformity defects, the customer is entitled to the replacement of the goods with no charge.

The warranty is only valid if the product comes with a valid proof of purchase (receipt or invoice).

The non-conforming product must be sent back to a Service Centre or authorized retailer, who, if necessary, will forward it to:

**GLOMEX S.r.l.**  
**Via Faentina 165/G**  
**48124, Ravenna (Italy)**

complete with all the accessories supplied at the time of purchase for a refund.

The serial number must neither be erased nor made illegible, otherwise the warranty will be voided.

### CAUTION

---

Conserve the installation and user manual with care! Losing the serial number makes the warranty null and void!

---



The warranty does not apply in case of damage due to carelessness, use or installation not compliant with the instructions given, tampering, product or serial number modification, damage due to accidental causes or to the buyer's negligence.

Moreover, warranty does not apply in case of damage consequent to connections of the equipment to different voltages than those indicated or to sudden voltage variations of the network the equipment is connected to, as well as in case of damage caused by leakage, fire, inductive/electrostatic discharges or discharges due to lightning, use of cables different to those provided, overvoltages or other phenomena not related to the equipment.

**Finally, the warranty does not apply to problems caused by the telephone operator and at a WI-FI hotspot.**

The parts subject to wear consequent to use such as connection cables, connectors, external parts and plastic supports are covered by a one-year period warranty.

The following are not covered by warranty: periodic monitoring, software updates, settings of the product, maintenance.

After the expiration of the warranty period, the technical support activities will be carried out charging the customer for the replaced parts, the labour costs and freight charges, according to current rates.

**The equipment will be replaced or repaired under warranty only and exclusively on Glomex quality department's approval.**

Should any dispute rise, the place of jurisdiction will exclusively be Ravenna (Italy).

The warranty is provided by:

**GLOMEX S.r.l.**  
**Via Faentina 165/G**  
**48124 Ravenna (Italy)**

## **1.4 GENERAL SAFETY RULES**

Carefully read the instructions and follow the recommended precautions to avoid potential hazards and safeguard your health and safety, before carrying out any installation and maintenance.

This manual contains the following indications:



---

This symbol warns against potential damage to the equipment which could involve the operator's safety.

---



## weBBoat 4G

Failure to comply with the instructions preceded by the above-mentioned keywords (WARNING) can cause serious accidents or even the death of the persons involved.

Moreover, in this Manual, some instructions are given with text in italics, preceded by the word NOTE.

The information and specifications given in this manual are based upon the information available at the moment it is written.

In case of doubts, do not hesitate to contact GLOMEX S.r.l. to the following email:

service@glomex.it

### 1.5 ENVIRONMENT

Do not throw the appliance away with the normal household waste at the end of its life, but hand it in at an official point for recycling. By doing this, you will help preserve the environment.



Fig. 1

GL00024

## 2. PRODUCT DESCRIPTION

weBBoat 3G/4G IT1004 is the new integrated system for surfing the internet with 4G network and Wi-Fi both with the boat anchored in the harbor and along the coast at more than 10 nautical miles, suitable for all types of boats, ships and yachts where coverage of GSM networks and Wi-Fi permits. The weBBoat 4G is also compatible with LTE, 3G systems, UMTS and GPRS data.

**NOTE The distance from the coast within which the weBBoat works depends on the 3G/4G signal coverage from the transmitter of your telephone operator, on the correct installation of weBBoat and on its height.**

Inside the ASA radome there is a 3G/4G antenna, a Wi-Fi antenna, a specifically constructed router with dedicated software to operate on the boat and an access point which, protected from the elements, allow you to have a simple and convenient high-speed internet connection on your boat in a few

minutes: simply insert a SIM card (not supplied) into the external slot and you can connect in Wi-Fi any internet devices (iPhone, smartphone, iPad, tablet, PC...) to the Wi-Fi network of the harbor or to the 3G network. In addition, the router inside the radome compact size (250mm/10" in diameter and 300mm/12" in height), it automatically switches from 3G/4G network to the Wi-Fi network (where you have already registered), and vice versa to be certain of an internet connection without interruptions and cost-effective. Finally, to manage in an extremely easy and convenient manner the integrated system, weBBoat Glomex also offers an App for iOS and Android.



**Fig. 2**



## weBBoat 4G

### 3. CONTENTS

The weBBoat is shipped packed in a cardboard box and sealed with the strapping GLOMEX

"SEAL OF SAFETY" which acts as a seal for the WARRANTY OF CONTENTS.

Upon receipt, check that:

- the packaging is whole and the warranty hoop is present;
- the supply matches the order specifications;
- there is no damage to the antenna;
- there is the label with SSID, S/N and PASSWORD to access the weB-Boat. This label is present on page 1 of this manual.

In case of damage or missing parts, immediately inform the Retailer, if possible with appropriate photos.



Fig. 3



GL00152

Fig. 4

GL00184



## 3.1 INSTALLATION

### Installation on sailboats

It is advisable to place the weBBoat to a maximum height of 8/10 meters on the shaft cross with the support Glomex code ITM001 (not supplied). The weBBoat must be fixed to the support by tightening the screw on the bottom of weBBoat with a screwdriver (Fig. 6).

**IMPORTANT:** Do not install the weBBoat masthead.

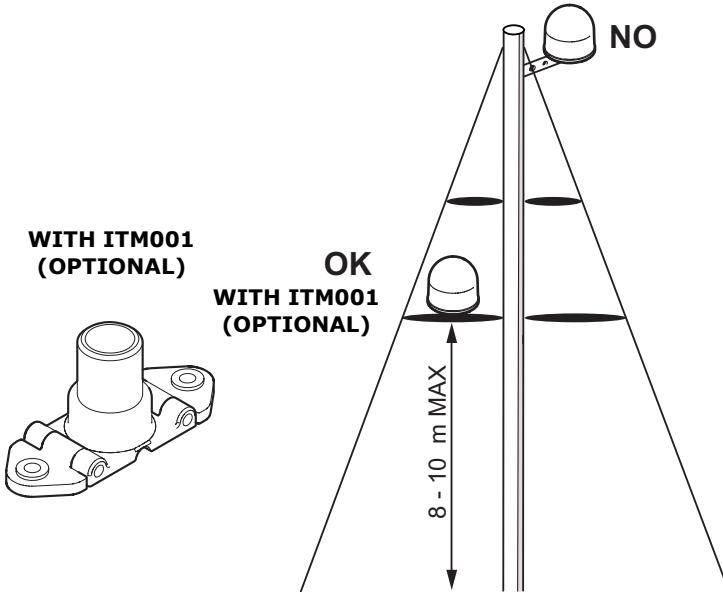

Fig. 5

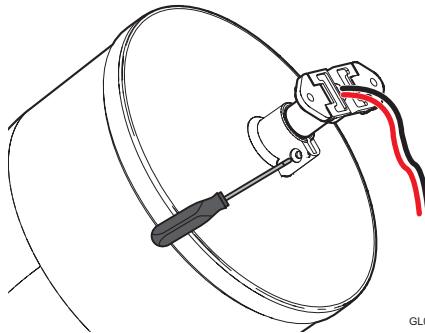
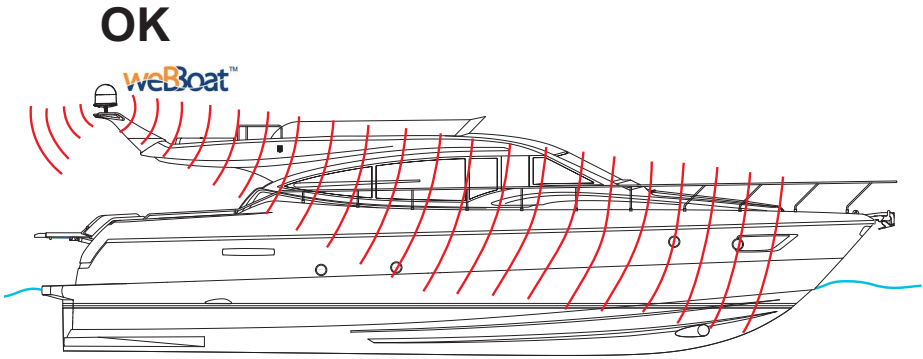

Fig. 6

**Installation on motor boats in fiberglass**



GL00154

**Fig. 7**

**Installation on motor boats in metal**

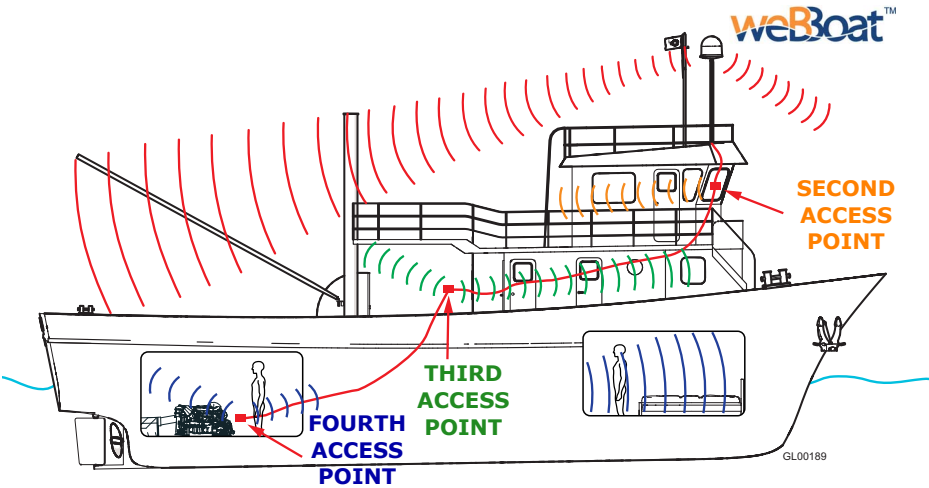

GL00189

**Use up to 4 access points**

**Fig. 8**



**Warning:**

- The weBBoat must be fixed to a base/support by tightening the screw in the base of the weBBoat by means of a screwdriver (Fig. 6 ).
- The installation of the weBBoat near or above a flat metal surface may result in significant reduction of the Wi-Fi and 3G/4G signal strength.
- Do not mount the weBBoat near metal obstructions that may interfere with the Wi-Fi signal.

On metal crafts, the Wi-Fi signal is blocked, for this reason it is necessary to place a second access point (up to a maximum of 4 APs) inside the boat and connect them with a switch (optional) to the router inside of weBBoat via an Ethernet cable (optional) (Fig. 9). The access point present inside the radome can be used for the Wi-Fi coverage outside the boat.

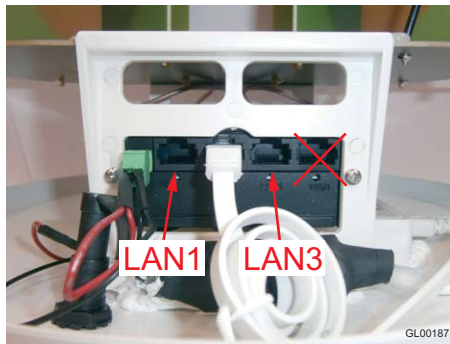
**Fig. 9****Electric connections**

For the proper functioning of weBBoat, simply connect the antenna to a 12/24 Vdc power supply cable (not provided) according to the following guidelines.

Connect the red (positive) and the black wire (negative) coming out from the base of weBBoat to the battery through a red/black power cable. The connection can be made by soldering or with a clamp. It is advisable to have this procedure carried out by a technician.

**IMPORTANT:** The polarity reversal on the power supply will burn the fuse. The power line (not supplied) which connects the two wires coming out from the base of weBBoat must have cables with a cross section of 1.5 mm<sup>2</sup> by a length up to 10 m, and 2.5 mm<sup>2</sup> for longer lengths.

**WARNING:** in the power line, we recommend placing a switch upstream to avoid electricity consumption when the weBBoat is not used.

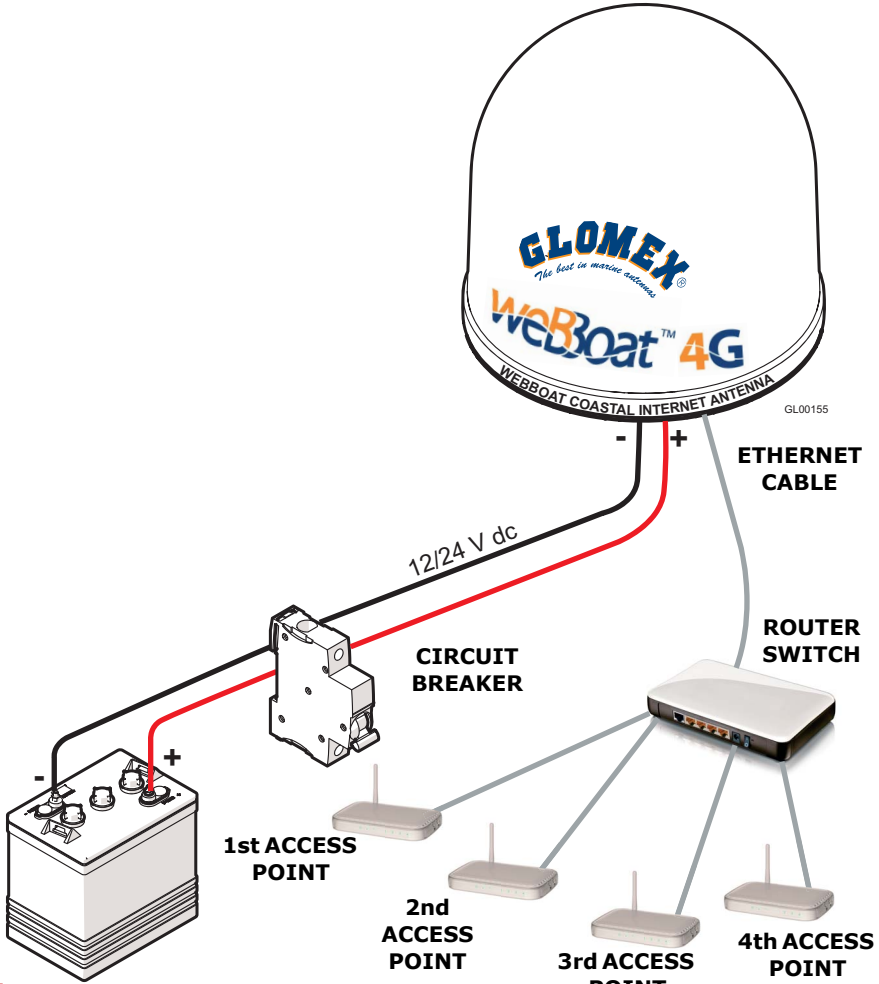

**Fig.10**

**NOTE:** In order to receive the signal from the weBBoat inside metal crafts, up to a maximum of four access points (according to your needs) must be placed inside the boat, which must be linked with a switch to the router inside the weBBoat via an Ethernet network cable.

## 3.2 INSERTING THE SIM CARD

Insert the **SIM CARD** into the upper socket of the "**EXTERNAL SLOT**" of the weBBoat, which is located at the bottom of the radome. Insert the SIM card **with the contacts facing down and the cut edge of the SIM facing outward**, as shown in Fig. 11.

**NOTE** Insert the **SIM CARD** with weBBoat off.

**IMPORTANT:** If the **SIM card has a PIN**, you must remove the PIN code request before inserting the SIM card into weBBoat. This can be done via a mobile phone and varies according to the individual mobile phones. Please check the steps in the instructions of your mobile phone, or contact your operator.

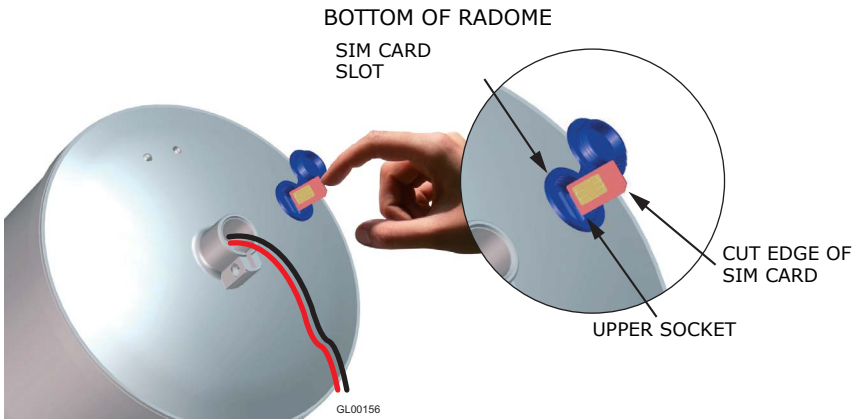

**Fig.11**

## 4. HOW TO DOWNLOAD CONTROL APP FOR weBBoat

Register your weBBoat with the free downloading of the Glomex App from the Apple Store for Apple devices or from the Play Store for Android devices.



The App Glomex for weBBoat is essential to setup the weBBoat.



**Fig.12**

GL00158

**IMPORTANT:** The app instructions should be used only by the weBBoat administrator (using only one device). After following all the steps in the following instructions, all the other internet devices (up to 31) must simply select the wi-fi network of the webboat and enter the password, if required.

**After the download**, activate the Wi-Fi connection, then connect to the weBBoat. The weBBoat network name is "WeBBoat 4GXXX" (Fig. 13); access to the network requires a password. The password is shown on the label on page 1 of this manual.

**Please note YOU MUST CONNECT YOUR IOS OR ANDROID DEVICE TO THE WI-FI NETWORK OF THE WEBBOAT AND NOT TO THE HARBOR, OFFICE NETWORK OR OTHERS.**



**Fig.13**

## 5. FIRST TIME SETUP

The weBBoat has only one administrator who needs to do the following setup once with a single device.

**Open the App** and select the language clicking the flag (Fig. 14).

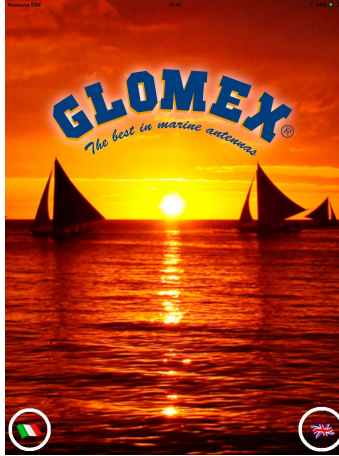

Fig. 14

**If the Wi-fi is connected**, the page is displayed (Fig. 15). If the app does not work, check the presence of connection. In this case, check that the weBBoat Wi-Fi connection is enabled and try again.

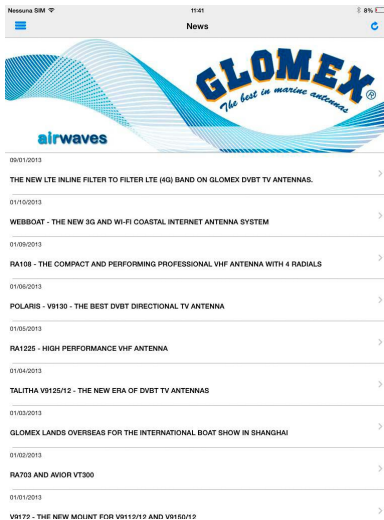

Fig. 15





After selecting the language, open the drop-down menu on the left and select "weBBoatCoastal Internet" (Fig. 16).

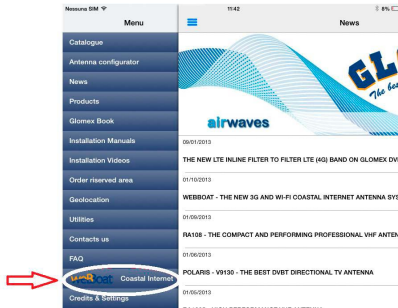

Fig.16

When you first open the app you will be asked to record some data, fill in the request form, then click the **Registra/Salva [Record/Save]** button and wait (Fig. 17).

Fig.17

**IMPORTANT:** Fill in the **WeBBoat S/N (serial number)** field with the **correct code**, located on the first page of this manual or on the box or on the router inside the WeBBoat (Fig. 18).

WEBBOAT IT1004  
**S/N: W4014/000000900**  
 SSID: WeBBoat\_4G\_C85FF6  
 PASSWORD: EDC85FF6  
 RUT550 SERIAL: 04224467

Fig.18

**If the WeBBoat S/N (serial number) field is not complete, we can not guarantee immediate assistance.**

When you are prompted for a password, enter **admin01** (Fig. 19)

Fig.19



## weBBoat 4G

After your registration, the page "weBBoat control App" will open. **Some information may be missing on the page**, in this case you must refresh it. Click the refresh button at the top of the page (Fig. 20) and wait until the process is complete. This could take a while.

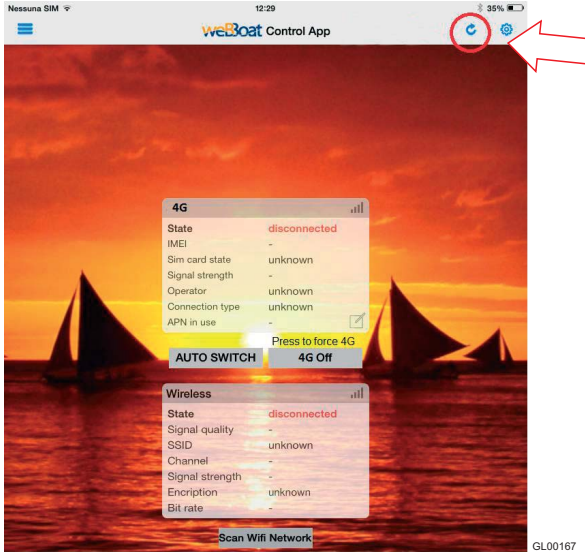

Fig.20

Once refreshed, the page will have all the necessary information. You will also notice that the "4G in use" button is green; this means that the 4G is active (Fig. 21).

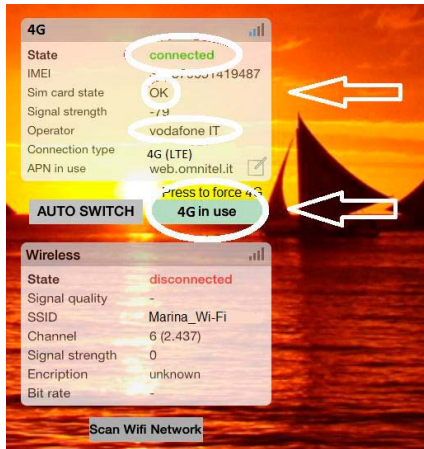

Fig.21

To continue , click "APN in use" (Fig. 23), click the World icon at the top (Fig. 22) and select your country from the list (Fig. 24); select the APN compatible with your operator (Fig. 25) and click "OK" to confirm.

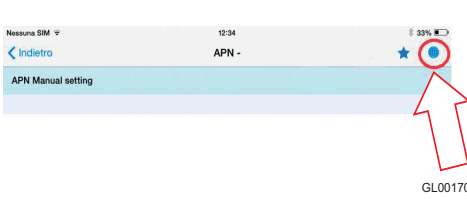

Fig.22

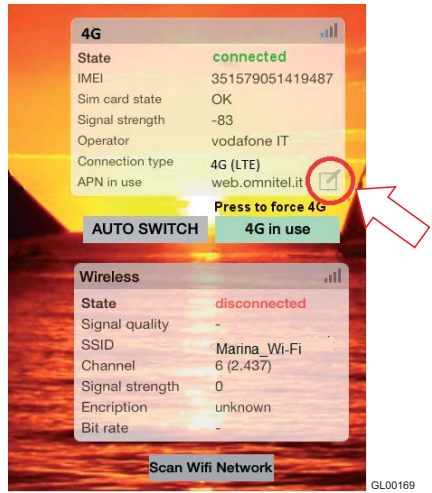

Fig.23

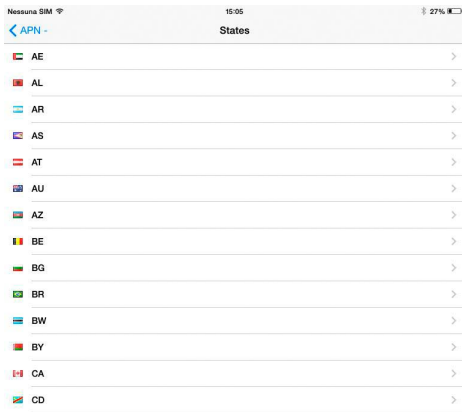

Fig.24

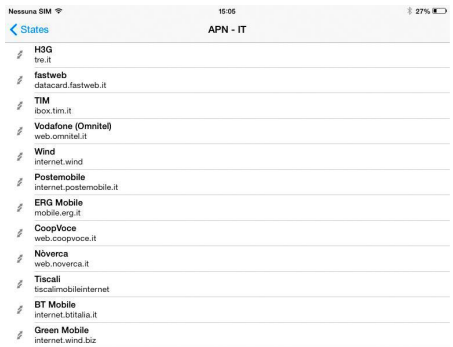

Fig.25



# weBoat 4G

**NOTE** If your compatible APN is not in the list, click States to go back (Fig. 26) and click APN- (Fig. 27). At this point you will see the "Manual APN setting" screen; click the "arrow" at the top (Fig. 28) and fill in the information requested on the form. Once this is done, click Salva [Save] (Fig. 29). If you do not know the APN of your device, contact your service provider.

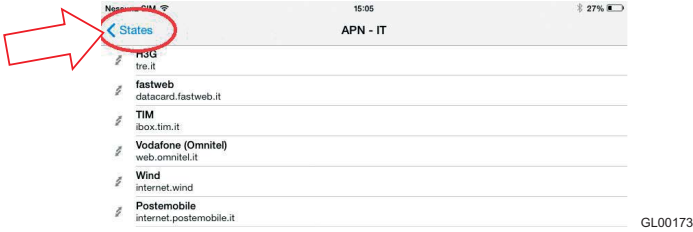

Fig.26



Fig.27



Fig.28

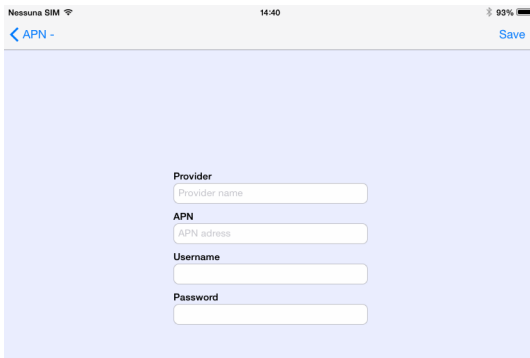

Fig.29



If, by mistake, you select the wrong operator, click Cancel and select again. In case of an error in the selection of the state, click the world icon to return to the list and select the correct state.

Once all the information provided is correct, click "OK" (Fig. 30) and wait for the setup.

**Note:** this process could take a few minutes.

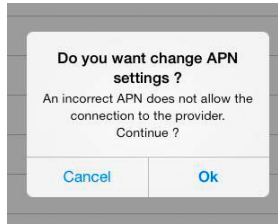

**Fig.30**

**Once the configuration was successful,** the weBBoat is ready to surf the internet using the 4G mode.

### ⚠ CAUTION

If the App is not correctly set, the device cannot browse the internet through the 3G/4G. Some operators have dedicated APN for special contracts; in this case, contact your service provider.

**Note:** ensure that the App is correct and installed.



**Fig.31**

## weBBoat 4G

If you want to add a Wi-Fi connection external to the 4G weBBoat to share with the devices on the boat, click "Scan Wi-Fi Network" (Fig. 32) and wait. A list of available connections will be displayed. Click the name of the Wi-Fi connection required (Fig. 33) and click OK to confirm. Enter the password for the Wi-Fi network selected and click OK/CONNECT (Fig. 34), and wait a few minutes. Now, the information of the Wi-Fi network you have chosen will appear in the Wireless table (Fig. 35).

**The "auto switch" button is green and the "4G Ready" is yellow.** This means that you are using the selected Wi-Fi network (SSID) to surf the internet.

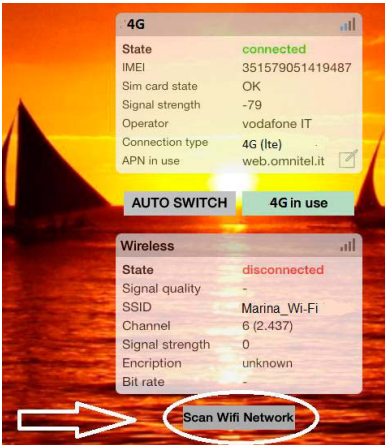

Fig.32



Fig.33



Fig.34



Fig.35



**⚠ CAUTION**

Some hotspots cannot be used by the weBBoat because the device is recognized as a router.

**Finally**, to return to the 3G/4G, click the yellow button "4G Ready" (Fig. 36). Wait a few minutes for the setup. At the end of the procedure, the "4G Ready" button is green (Fig. 37). This means that now you are connected to the internet in 4G mode.

**NOTE** The use of the external Wi-Fi network has priority over 3G/4G to limit the service costs.

weBBoat automatically switches between the harbor or land Wi-Fi to 3G/4G when the Wi-Fi signal is no longer received.

If the Wi-Fi signal is weak, you can force the use of 3G/4G by clicking on "4G READY" (Fig. 35).



**Fig.36**



**Fig.37**

**WARNING:** if you change the SIM card in the weBBoat, repeat the procedure from chapter 5.

# weBBoat 4G

**NOTE:**

